

INSTALLATION, SERVICE AND MAINTENANCE INSTRUCTIONS

MAGNETIC AGITATOR BMA



Translation of the Original Instructions
20.055.30.01EN
(A) 2023/03

INOXPA S.A.U.

Telers, 60
17820 - Banyoles (Spain)

hereby declare under our sole responsibility that the

Machine: **MAGNETIC AGITATOR**

Model: **BMA**

Type: **BMA-100, BMA-125, BMA-150, BMA-175,
BMA-200, BMA-225, BMA-275, BMA-300,
BMA-325, BMA-350, BMA-400.**

Size: **IXXXXXXXXXX to IXXXXXXXXXXX
XXXXXXXXXXIINXXX to XXXXXXXXXXXIINXXX**

fulfills all the relevant provisions of the following directive:

Machinery Directive 2006/42/CE
Low Voltage Directive 2014/35/UE
Electromagnetic Compatibility Directive 2014/30/UE
ATEX Directive 2014/34/UE only if it has any of the following markings

 II 2G Ex h IIC T4...T2 Gb 0°C ≤ Ta ≤ 40°C

 II 2D Ex h IIIB T135°C...T300°C Db 0°C ≤ Ta ≤ 40°C

 II 2G Ex h IIC T4...T2 Gb 0°C ≤ Ta ≤ 40°C
II 2D Ex h IIIB T135°C...T300°C Db 0°C ≤ Ta ≤ 40°C

and with the following harmonized standards and/or regulations:

**EN ISO 12100:2010, EN ISO 60204-1, EN 1127-1:2019, EN ISO 80079-36:2016,
EN ISO 80079-37:2016, IEC/TS 60079-32-1:2013.**

The technical file has been prepared by the signer of this document.

A copy of the technical file is in the possession of the notified body L.C.I.E. with reference number 0081.



David Reyero Brunet
Technical Office Manager
6th March 2023



INOXPA S.A.U.

Telers, 60
17820 - Banyoles (Spain)

hereby declare under our sole responsibility that the

Machine: **MAGNETIC AGITATOR**

Model: **BMA**

Type: **BMA-100, BMA-125, BMA-150, BMA-175,
BMA-200, BMA-225, BMA-275, BMA-300,
BMA-325, BMA-350, BMA-400.**

Serial number: **IXXXXXXXXXX to IXXXXXXXXXX
XXXXXXXXXXIINXXX to XXXXXXXXXXXIINXXX**

fulfils all the relevant provisions of these regulations:

**Supply of Machinery (Safety) Regulations 2008
Electrical Equipment (Safety) Regulations 2016
Electromagnetic Compatibility Regulations 2016
Equipment and Protective Systems Intended for Use in Potentially Ex-
plosive Atmospheres Regulations 2016** only if it has any of the following markings

 II 2G Ex h IIC T4...T2 Gb 0°C ≤ Ta ≤ 40°C

 II 2D Ex h IIIB T135°C...T300°C Db 0°C ≤ Ta ≤ 40°C

 II 2G Ex h IIC T4...T2 Gb 0°C ≤ Ta ≤ 40°C
II 2D Ex h IIIB T135°C...T300°C Db 0°C ≤ Ta ≤ 40°C

and with the following designated standards:

**EN ISO 12100:2010, EN ISO 60204-1, EN 1127-1:2019, EN ISO 80079-36:2016,
EN ISO 80079-37:2016, IEC/TS 60079-32-1:2013**

The technical file has been prepared by the signer of this document.

A copy of the technical file is in the possession of the notified body L.C.I.E. with reference number 0081.



David Reyero Brunet
Technical Office Manager
6th March 2023



Document: 20.055.30.04EN
Revision: (0) 2023/03

1. Introduction	
1.1 Purpose of this use and maintenance manual.....	5
1.2 Intended readers	5
1.3 Keeping the use and maintenance manual.....	5
1.4 Definitions – applied pictograms and standards	5
2. General Safety Requirements	
2.1 Safety provisions for ATEX versions.....	9
3. General Information	
3.1 Machine identification.....	10
3.2 Warranty information	10
4. Machine Description	
4.1 BMA magnetic agitator	12
4.2 Magnetic drive system.....	13
4.3 Designation	13
4.4 Agitator technical data.....	13
4.5 Environmental conditions	13
4.6 Noise	13
4.7 Lighting.....	14
5. Installation	
5.1 General warnings	15
5.2 Storage and packing	16
5.3 Handling the machine.....	17
5.4 Installing the BMA agitator	17
5.5 Shroud installation guide	17
5.6 Bushing mounting instruction	20
5.7 Pivot mounting instructions	21
5.8 Positioning on the tank	22
5.9 Grounding.....	22
5.10 Connecting the power supply.....	22
5.11 Motor – electrical connections.....	23
6. Using the machine	
6.1 Intended use.....	25
6.2 Improper and prohibited uses	25
6.3 Start-up.....	25
7. Safety	
7.1 Danger zones and residual risks.....	29
7.2 Safety devices and guards installed.....	29
8. Maintenance	
8.1 Safety precautions.....	30
8.2 Routine maintenance	32
8.3 Cleaning	32
8.4 Extraordinary maintenance	32
9. Disassembly and disposal	
9.1 Disassembly sequence	34
9.2 Disposal.....	34

1. Introduction

1.1 PURPOSE OF THIS USE AND MAINTENANCE MANUAL

This instruction manual is an integral part of the machine and is intended to provide all the information necessary for:

- Getting to know the machine and how it works
- Knowing the intended operating methods and limits of use
- Making operators properly aware of safety issues;
- Handling the machine;
- Correct installation of the machine;
- Correct and safe use;
- Carrying out routine maintenance operations correctly and safely;
- Dismantling the machine safely and in compliance with the regulations in force to protect the health of workers and the environment



This manual contains important information for the installer and the operator for reliable, correct and effective operation, maintenance and repair.

Our warranty is subject to compliance with the instructions in this manual. It must always be kept close to the place of operation of the machine / unit for easy access.

This document assumes that the current safety and hygiene regulations in force are observed in the workplace where the machine is installed, and therefore that all people involved in operation, maintenance, inspection and installation of the machine must be qualified. Consequently:

The instructions, drawings and documentation contained in this manual are of a confidential technical nature, strictly owned by the manufacturer, and may not be reproduced in any way, neither in full nor in part.

The sequence of chapters follows the chronological order of the machine service life.

1.2 INTENDED READERS

This manual is intended for installers, operators, maintenance technicians and all qualified personnel who can intervene or interface with the machine at any level.

Qualified personnel means those people who, on the basis of their preparation, experience, education and knowledge of the main standards and specifications, accident prevention rules and working conditions, have been authorized by the plant safety managers to carry out the interventions on the AGITATOR, and who are able to recognize and avoid any possible danger.

The AGITATOR is equipment for professional use according to the methods specified in this manual. Any other way of using it is to be considered improper and therefore prohibited.

Warning: Unqualified personnel are not authorized to work on or near the AGITATOR

INOXPA. shall not be held liable for problems, breakages and accidents due to failure to apply the instructions contained in the manual, failure to comply with current regulations or failure to apply due diligence when carrying out maneuvers, maintenance or repairs, even if not expressly mentioned in this manual.

The manual was drafted with the technical knowledge current when the AGITATOR was sold, so it cannot be considered inadequate if new knowledge comes to light after it was marketed.

The employer is responsible for disclosure of this document to all personnel who will interact with the machine and who will use and maintain it.

The employer undertakes to request the parts and / or the complete manual if it is lost or destroyed.

1.3 KEEPING THE USE AND MAINTENANCE MANUAL

This use and maintenance manual for the machine described must be kept near the machine by the person in charge. It must be kept in perfect condition and available to anyone who explicitly requests it, provided that they are in some way linked to machine operation.

1.4 DEFINITIONS – APPLIED PICTOGRAMS AND STANDARDS



1.4.1 Definitions

To facilitate the immediate understanding of the text, this paragraph clarifies the meanings of the terms, abbreviations and pictograms used in the manual. Their use makes it possible to quickly and unambiguously provide the information necessary for correct and safe use of the machine.





For the purposes of this document, the terms and definitions referred to in the EN 12100 standard, applicable for

the machine in question, have been adopted. For details, refer to the Regulations in question.

1.4.2 Pictograms

	The descriptions preceded by this symbol and possibly associated with a specific danger sign, contain very important safety-related information / instructions. Failure to comply can lead to hazards to operator safety;
	The requirements provided together with this symbol, highlighted by a green side border, refer exclusively to equipment that complies with the ATEX Directive 2014/34 / EU (products intended for use in areas at risk of explosions).
	The manual drafted for the ATEX directive is an integral part of the use and maintenance manual.











PICTOGRAMS RELATING TO THE OPERATOR QUALIFICATIONS

SYMB.	DESCRIPTION
	1st level machine operators: operators without specific skills, able to perform only simple tasks, namely operating the machine through use of the push-button panel, loading and unloading the materials used during production, with the guards installed and active; they are not authorized to use the machine with hold-to-run (JOG) controls.
	Lifting and handling equipment drivers: operators authorized to use equipment for lifting and handling materials and machines (carefully following the manufacturer's instructions), in accordance with the laws in force in the country of the machine user.
	Mechanical maintenance technicians: qualified technicians able to operate the machine in normal conditions, to operate it with hold-to-run (JOG) controls with the guards deactivated, and to work on mechanical parts to carry out the necessary adjustments, maintenance, and repairs. Typically, they are not authorized to work on live electrical systems.
	Electrical maintenance technicians: qualified technicians able to operate the machine in normal conditions, to operate it with hold-to-run (JOG) controls with the guards deactivated, and to carry out the necessary electrical adjustments, maintenance, and repairs. They can work inside live cabinets and junction boxes.
	Manufacturer's technicians: qualified technicians made available by the manufacturer to carry out complex operations in specific situations or, in any case, as agreed with the user. Depending on the case, they may have skills of a mechanical and / or electrical and / or electronic and / or software nature.

Pictograms for Operators

SAFETY PICTOGRAMS

- Pictograms contained in a triangle indicate HAZARDS.
- The pictograms contained in a circle impose a PROHIBITION / OBLIGATION.

SYMBOL	DESCRIPTION
	Generic hazard
	Live parts hazard (AGITATOR motor)
	Hot surfaces hazard (Motor / Gearbox / AGITATOR variator)
	Explosive atmosphere hazard
	Rotating parts hazard (AGITATOR)
	Confined environment hazard
	Hazard from contact with chemicals
	No unauthorized access
	Do not use naked flames
	Do not use water to extinguish fires on electrical parts
	Do not remove guards
	Always use mechanical lifting equipment
	Always use a protective helmet while handling with a crane
	Always ground the machine
	Always use respirators for access inside of the tank
	Always use safety shoes as per EN 388 during maintenance and handling of machinery
	Always use gloves as per EN 420 during installation and maintenance
	Always read the use and maintenance manual
	Always check the state of guards

Safety pictograms

2. General Safety Requirements



	All the precautions listed on this page must be strictly observed to avoid serious harm to people and / or the AGITATOR.
--	---

- Follow the intended performance and use.
- Any work on the AGITATOR must ALWAYS be carried out by at least 2 people, who must be qualified and expressly authorized.
- Approach the AGITATOR with suitable clothing (avoid clothing with wide sleeves, ties, necklaces, etc.) and personal protective equipment (helmet, goggles, gloves, shoes, etc.) suitable for the operation to be performed. Do not leave long hair loose.
- Do not remove the guards from rotating components while the AGITATOR is running.
- Refit any safety guards removed as soon as the reasons for their removal no longer exist.
- Do not operate the AGITATOR in the opposite direction to the specified direction of rotation as indicated on the AGITATOR motor.
- NEVER put your hands and / or fingers into holes and / or openings.
- Only specialist, qualified and authorized personnel may make the connections (electrical / pneumatic / hydraulic) to the AGITATOR motor, and only in accordance with the regulations in force.
- Disconnect the AGITATOR from the system and disconnect the power supply (electrical, hydraulic, pneumatic) when you need to work on it.
- Make sure you have taken the necessary measures to prevent the power from being turned on inadvertently.
- Make sure that the components are insulated correctly and that the ground connection has been made before switching on the power.
- The AGITATOR must be stopped before being touching it for any reason.
- The AGITATOR must not be hot when working on it.
- Make sure the AGITATOR is correctly fixed and is stable throughout the service life of the machine (handling, installation, etc.)

	CAUTION!
	The internal and external rotors contain permanent magnets that transmit a strong magnetic field; handling them in an uncontrolled manner could harm their performance (e.g. placing the rotors in an unclean environment containing ferrous dust, etc.)

	CAUTION!
	Do not bring credit cards, computer disks or other objects with magnetic strips close to the magnets.

	CAUTION! VERY DANGEROUS
	The wearers of "Pace-makers" should not get close to the magnets, "Pace-maker" malfunctions could occur, resulting in very serious risks for the wearer.

	CAUTION!
	Possible contact with hazardous materials or substances. The AGITATOR contains components that can cause hazards to exposed persons, even during normal use and / or maintenance procedures (see Table 4).
	If necessary, dispose of them in accordance with the laws in force and with proper management of the surrounding environment.

MATERIAL	USE	MAIN HAZARDS
Paint	External surface of the AGITATOR motor	Release of dust and smoke when processed, flammability
Oil	Gearbox / Variator lubrication	Contact during replacement/troubleshooting

Materials

2.1 SAFETY PROVISIONS FOR ATEX VERSIONS

	<p>SAFETY NOTES</p> <p>For use in accordance with the ATEX Directive 2014/34 / EU classification, respect the technical data indicated on the nameplate.</p> <p>The AGITATOR is intended for use in an environment with an explosion hazard due to the presence of gas-air and / or dust-air mixtures.</p> <p>Group II and category 2 equipment can only be used in zones 1, 21, 2, 22.</p> <p>Only use the AGITATOR in conjunction with other equipment if the latter can operate in at least the same areas. The characteristics of the explosive mixture must comply with the maximum temperature data given on the marking plate.</p> <p>If the AGITATOR is used in an explosive atmosphere composed of an air-dust mixture, the minimum ignition temperature of the dust cloud must be higher than the value given on the marking plate, multiplied by a coefficient of 1.5, plus 75 K if deposition of dust layers of less than 5 mm is expected.</p>
---	--

	<p>SAFETY NOTES</p> <p>All other assembled equipment should have certification attesting that the degree of protection is equal to or higher than that of the AGITATOR.</p>
--	--

	<p>SAFETY NOTES</p> <p>The AGITATOR is not designed to mix powders in the absence of liquids or in any case in the absence of a strongly preponderant amount of liquid.</p>
---	--

3. General Information



3.1 MACHINE IDENTIFICATION

In accordance with requirement 1.7.3 of Annex I to Directive 2006/42 / EC, each AGITATOR produced is equipped with an identification plate that, in addition to the manufacturer's data, shows the following (see Figure 1):



Facsimile of CE marking plate

	On ATEX versions, the plate contains a marking string in accordance with ATEX Directive 2014/34 / EU.
--	--

Below are some examples of markings and related legends

- II 2G Ex h IIC T4...T2 Gb 0°C ≤ Ta ≤ 40°C
- II 2D Ex h IIIB T135°C...T300°C Db 0°C ≤ Ta ≤ 40°C
- II 2G Ex h IIC T4...T2 Gb 0°C ≤ Ta ≤ 40°C
- II 2D Ex h IIIB T135°C...T300°C Db 0°C ≤ Ta ≤ 40°C

	<p>ATEX MARKING</p> <p>II: Group to which the equipment belongs 2: Applicable category: 2 -: Unclassified area /: Category separator (internal tank / external tank) G: Use in an explosive atmosphere composed of air mixed with gases, vapors or mists D: Use in an explosive atmosphere composed of air mixed with flammable powders Maximum surface temperature 135 °C–300 °C (T4...T2): The assembly consists of the motor, reduction gear or variator, bearing housing and AGITATOR. With an ambient and process temperature below or equal to 40 °C, the maximum surface temperature and / or the temperature class of the equipment does not exceed the values specified in the EU declaration of conformity and on the plate affixed to the equipment. If the process temperature is above 40 °C, the maximum surface temperature is obtained by adding 45 °C to the process temperature.</p> <p>EPL protection level of the equipment.; Gb: zone 1;2 Db zone 21</p>
--	--

3.2 WARRANTY INFORMATION

The Warranty shall not be valid if the machine has been damaged by improper or incorrect use, by negligence or accidental damage, or by use in unsuitable environments.

The machine warranty shall be recognized for all materials that exhibit accelerated wear for reasons related to defects not encountered during assembly and testing.

The warranty is valid within the limits and conditions outlined below:

- The machine is operated as specified in this Instructions manual; any other use is considered improper and shall therefore render the warranty null and void
- The machine must be undergo checks and maintenance, both routine and extraordinary, as specified herein.

The warranty on both mechanical and electrical parts is valid for 12 months.

The warranty period shall commence from the machine delivery date.

When parts are replaced or repaired under warranty at the customer site, all travel, room and board expenses are the responsibility of the buyer.

Warranty exclusions and limits

The warranty excludes all parts which, for reasons of normal wear and tear, must certainly be replaced before expiry of the warranty, such as:

- Gaskets
- Components for which it is not possible to establish the duration

4. Machine Description



The AGITATOR is a machine that transfers energy into a liquid to obtain a flow rate, head and shear, in proportions that depend on the rotation speed, type, diameter and number of impellers used.

The flow rate is used to increase the speed of the fluid as quickly as possible, the head serves to make the motion reach even the farthest points from the impellers, and the shear is used to overcome the surface tension between different phases to facilitate mixing / dispersion.

The type of flow produced (axial or radial) depends on the shape of the impellers used: impellers and turbines with angled blades produce axial motion, while turbines with straight blades produce radial motion.

AGITATORS are applied in the following industrial sectors:

- chemical and petrochemical
- pharmaceutical
- water treatment
- food
- energy production
- biotechnologies
- cosmetics

The machine basically consists of the control unit and the stirring unit.

The control unit consists of:

- a) motor,
- b) any reduction gear / variator, belt and pulley or bearing housing,
- c) sealing system.

If there are no particular reasons agreed with the customer, the control unit is shipped already assembled, ready to be installed on the tank or tub.

The interfaces are the tank fixing flange and the connection joint between the control unit and the agitation unit.

The AGITATOR unit is normally composed of two main parts:

- d) shaft (in one or more sections). The various shaft sections are connected by flanged joints
- e) one or more impellers,

4.1 BMA MAGNETIC AGITATOR

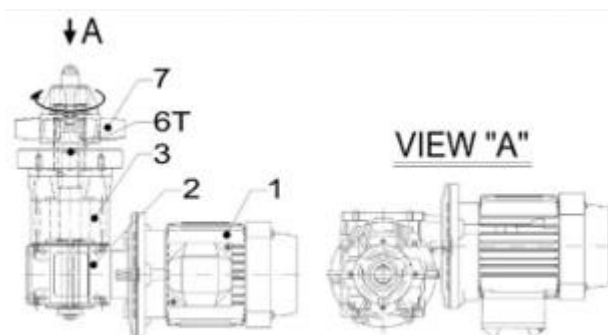

POS.	DESCRIPTION	
1	Motor	Electric / Pneumatic / Hydraulic
2	Gearbox	Coaxial gearbox / Parallel axis gearbox / Orthogonal axis gearbox / Worm reduction gear
3	Magnet housing	
6T	Magnetic coupling	
7	Impeller	

4.2 MAGNETIC DRIVE SYSTEM

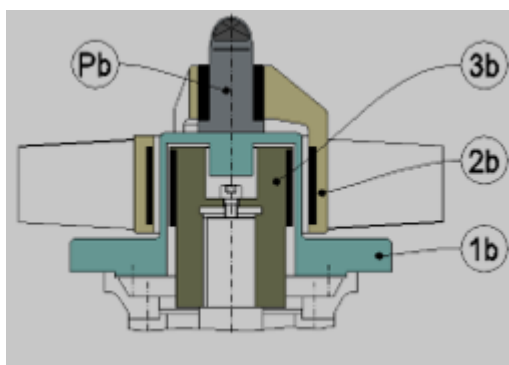

The magnetic drive system consists of:

1b - Closing shroud to be welded to the tank (1).

2b - Internal rotor complete with fully encapsulated permanent magnets that create agitation by means of the rotor blades (impeller).

3b - External rotor complete with permanent magnets (connected to the driving part) that transmit motion to the internal rotor by means of the magnetic field.

Liquid must circulate in the tank to ensure the operational safety of the magnetic drive.

(1) In some applications the shroud can be secured to the tank with a flanged coupling and sealing gasket.

4.3 DESIGNATION

The AGITATOR range includes a different number of models according to the different combination of components. Depending on the construction variants or the accessories installed, the AGITATOR type code can be completed by one or more letters as summarized in the following tables.

Position 1	Position 3		
Type / version	XX	YY	ZZ
BMA Bottom installation	Engine power [HP] x10	-----	-----

4.4 AGITATOR TECHNICAL DATA

Refer to the attached drawing for details of the AGITATOR technical data.



4.5 ENVIRONMENTAL CONDITIONS

The equipment is only allowed to operate with an ambient temperature T_{amb} between 0 °C and + 40 °C, unless otherwise specified and when the relative humidity does not exceed 50% at a maximum temperature of + 40 °C. Higher relative humidities are permissible at lower temperatures.

4.6 NOISE

The noise emission of the machine during normal operation is less than 85 dB. This value refers to an emission level and does not necessarily represent a safe working level. Other factors that affect the actual exposure level of operating personnel include:

- the working condition of the machine;
- the specific characteristics of the environment in which the machine is used;
- interaction of the noise produced by the machine with other noise sources;
- the location of the operating personnel.

	<p>The user and the employer must comply with the laws of the country where the machine is installed, regarding daily exposure of personnel to noise, with possible requirements to use PPE in relation to the overall sound pressure level in the work area</p>
	

4.7 LIGHTING

The minimum lighting must be such as to guarantee the correct perception of symbols and markings (about 500 lux).

The lighting level must always be such as to ensure the utmost safety during operation.

5. Installation



5.1 GENERAL WARNINGS

	<ul style="list-style-type: none"> – Installation procedures must be carried out without an explosive atmosphere. – During operation, the atmosphere must comply with the maximum surface temperatures specified on the plate, in accordance with the ATEX regulations – Provide suitable protection to prevent hazardous build-ups of dust / liquids near the seals and protruding shafts – Arrange appropriate periodic cleaning procedures to prevent the hazardous build-ups of dust near the seals and protruding shafts – For proper use together with other equipment (such as an electric motor) in an explosive environment, make sure that such equipment is ATEX compliant in at least the same category as the AGITATOR (see plate) – Components and accessory devices, such as the motor, lip seal, reduction gear, etc. must be used in accordance with the instruction manuals provided with the documentation supplied with the AGITATOR. – Make sure that the applied load does not exceed the values for which the AGITATOR is intended
--	--

	<p>When using a tank not supplied by the manufacturer, the user must ensure that the assembly is mechanically stable and provide a space of at least 20 mm between rotating and static parts.</p>
--	--

- Only properly trained operators who are informed about the work to be done may install the machine.
- Before proceeding with the installation, make sure that the equipment and materials are compatible with the process fluid and with the operating environment in which it will be installed.
- Check the space available for mounting.
- The equipment can induce vibrations during operation: during installation, make sure that this does not trigger resonances in the structure to which it is connected, and that it does not cause damage to the surrounding environment.
- The connection cables to the system must not in any way transmit stress and / or vibrations to the equipment
- Check that the support structure (beams, plates, flanges, etc.) has been correctly sized taking into account the static and dynamic loads produced by the AGITATOR.
- The anchor bolts must be suitable for the fixing holes (do not use undersized screws) and must be mounted with a plain washer and spring washer.
- Make sure there are vortex breakers when required in cylindrical tanks.
- Make sure that the disassembled impellers or those connected to the shaft can enter the container through the openings provided, without forcing.
- When installing outdoors, at least the electric motor must be protected by a roof.
- The motor-reduction gear-variator-bearing housing assembly normally constitutes a single unit that must be fixed to the support structures. Respect the tightening torques (see table paragraph 8.2.3 Tightening torques), and make sure that it is level to ensure that the shaft rotates without oscillations that could quickly jeopardize mechanical stability.
- Make sure that the impellers are mounted in accordance with the direction of rotation, and fixed securely to the shaft; when fixing with dowels, find the correct dowel position and then prepare "slots" in the shaft for the dowels, if not already provided.
- If there are two or more impellers, check the mutual distance along the shaft.
- Do not flex the shaft while inserting it into the container and must, and do not position in such a way that it has to support the weight of the drive unit.
- If the shaft and / or impellers are made of several flanged parts, couple the parts in accordance with the markings applied in the factory, and tighten the connection bolts to the correct torques (see table Tightening torques paragraph 8.2.3).

- A temperature that is too cold, ice or snow could create problems with the process fluid or equipment, resulting in a risk of cavitation, as well as causing permanent deformation of the equipment and damage to the seals; comply with the environmental operating conditions of the equipment.
- Protect the equipment from the weather, which, while not compromising safety and operation, can reduce its service life in the long run.
- Finally, arrange for the assembly of any accessory elements, if supplied separately.
- Make sure that the installation environment is protected against lightning and stray electric currents not directly attributable to the activity.

Only properly trained operators who are informed about the work to be done may install the machine.

Operators must use suitable means to carry out the installation operations safely: therefore, please note that all the equipment used for installation must be in perfect condition and must be used as intended by the respective manufacturers.

The choice of the place or spaces is important for the quality of the work (maintenance, safety, etc.): this area must be well lit and ventilated.

The environmental and operating conditions must not hinder access to the controls.



Make sure the lifting equipment is in good working condition before starting to move the machine.

During lifting and transport, take every possible precaution to prevent hazardous movements that could cause accidents or harm people or property.

During lifting, avoid sudden movements that could damage the machine.

Only expert personnel may carry out lifting. Make sure there are no exposed persons in the danger zone.

Lifting must be carried out continuously (without jerking). For better load stability, keep the load as low as possible when moving.

	<p>CAUTION! Beware of suspended loads during lifting and transport. The machine must always be in a stable and safe position. The area involved in the handling and the surrounding areas are to be considered danger zones while carrying out these procedures.</p>
	<p>CAUTION! Only move the machine with vehicles whose minimum capacity is greater than the declared mass of the machine. Make sure that the lifting equipment is in good working condition and check its capacity before starting handling.</p>
	<p>CAUTION! When the AGITATOR is delivered already assembled or when the AGITATOR is already installed, avoid gripping the shaft during handling. In fact, sudden loads and movements can affect the straightness of the shaft.</p>

5.2 STORAGE AND PACKING

5.2.1 Packing

The machine is transported and delivered partially assembled and housed on pallets.

Before handling and unpacking the machine components, check their integrity and the total absence of any type of potential damage suffered during transport.

Pay particular attention to verifying that the shaft is perfectly straight.

Check that the weight and dimensions are as shown in the drawings and indicated on the packaging.

5.2.2 Storage

We recommend storing the AGITATOR on pallets or other packaging supplied by the manufacturer, in a suitable place, covered and protected from the weather. The storage place must not be exposed to high temperature changes that could damage the electrical equipment, and must ensure protection from humidity, extreme temperatures (below -20 °C and above + 40 °C) and condensation. No other type of material or equipment must be stacked on top of the packed machine.

5.2.3 Prolonged storage

For storage periods exceeding 3 months, coupling surfaces such as flanges, shaft ends and impeller bores must be protected with a suitable antioxidant product. The reducers, on the other hand, must be positioned with the breather plug in the highest position and filled entirely with oil. For information on the type of oil used for the first filling, contact the manufacturer.

Restore the correct amount of oil before starting the AGITATOR.

5.3 HANDLING THE MACHINE



The pallet can be moved by means of a suitable lifting equipment with forks, to be positioned in the appropriate seats in the pallet.

During handling, make sure that there are suitable maneuvering spaces, and suitable clutter-free, smooth surfaces free of clutter, and that there are no people along the maneuvering and transport path.

Only after checking the stability of the machine and its components on the pallet, lift it to the minimum height necessary for handling, avoiding oscillations and impacts that could damage the machine or pose hazards.

Place the pallet on the ground near the installation site.

Remove the package fastening straps one at a time, always checking the stability of the machine and components in order to avoid potentially hazardous sudden slips.

For the following phases the machine can be moved:

- by means of ropes / chains hooked to the eyebolt located on the connection flange of the control unit in models equipped with this system;
- by means of a barycentric sling.

Before transporting and handling, check that the weight and dimensions are as shown in the drawings.

	<p>CAUTION!</p> <ul style="list-style-type: none"> - Do not transport the tank with the AGITATOR installed. - The AGITATOR must be installed on site.
--	--

5.4 INSTALLING THE BMA AGITATOR

CAUTION!! Please read “1 GENERAL SAFETY REQUIREMENTS”

	<p>CAUTION!</p> <p>To avoid any damage, only qualified personnel may carry out the assembly, and only with the utmost care and attention in accordance with the diagram and procedure in paragraph 4.2.</p>
--	--

- Weld the shroud "**1b**" as described in the chapter 5.5. Shroud installation guide.

	<p>CAUTION!</p> <p>To avoid breaking the guide pin "Pb" and impeller bushing "2b", it is very important to install the impeller (internal rotor) "2b" before fitting the external rotor "3b", which is secured to the drive unit.</p>
--	--

- Install the guide pin "**Pb**", as described in the chapter 5.6 Bushing mounting instructions and 5.7 Pivot mounting instructions.
- Inside the tank, gently insert the impeller (internal rotor) "**2b**", on the guide pin "**Pb**", previously installed on the shroud "**1b**".
- Assemble the drive unit with the utmost care, taking care not to bump the external rotor "**3b**" secured to the drive unit against anything.

5.5 SHROUD INSTALLATION GUIDE

5.5.1 Shroud orientation

The orientation of the mixer foresees that the shrouds with diameter less than 119 mm have threaded holes on the center axle of the motor.

On the contrary, shrouds with diameter more than 119 mm, have threaded holes positioned at 45° from the motor center axle, except that differently specified on the drawing.

Figure 1 shows the bottom of the vessel seen from above (inside):

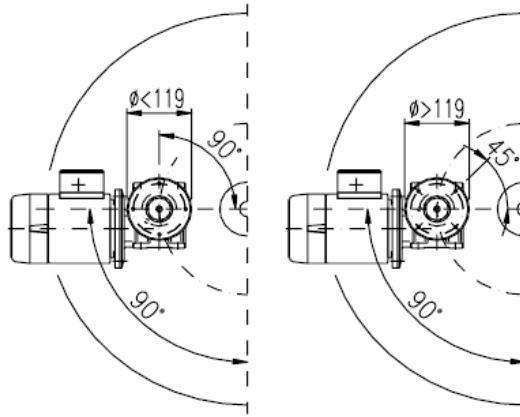

Fig. 1

5.5.2 Positioning

5.5.2.1 Free distance between welds

Before position the shroud check that the minimum distance (WD) between the shroud welds and any other weld correspond to the vessel technical specifications.

Calculation to be used in order to find the correct positioning of the shroud in the vessel	Vessel diameter D_e	Distance D
	< 1000 mm	0,5 x LR
> 1000 mm	0,3 – 0,5 x LR	

This table is to be considered valid only if not in contrast with chapter 5.5.2.1 Free distance between welds.

5.5.2.2 Direction

The shroud must be welded flush with the inner surface of the vessel. Its axle shall be perpendicular to the bottom of the vessel crossing the vessel axle as shown in figure 2:

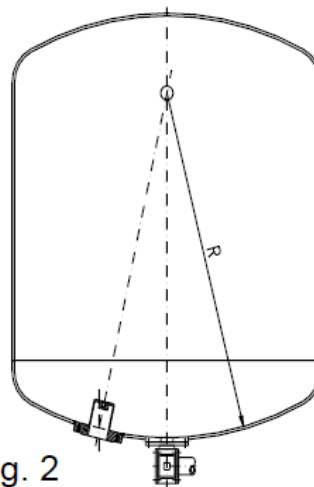

Fig. 2

5.5.2.3 Making the hole for the shroud

Before making the hole in the vessel make sure that all the welds on the vessel are completed, for example outlet valves, connections for sensors, etc.

Holding into consideration the recommendations of chapter 5.5.2.1 and 5.5.2.2. make the hole in the vessel, that shall be of the same diameter of the shroud, avoiding to leave any air gap between the shroud and the edge of the hole.

The inner edge of the vessel must be round in order to make a 45° angle sloping inwards (creating a weld groove). On the outer edge of the hole must be left a straight part of approx. 2 mm as shown in figure 3

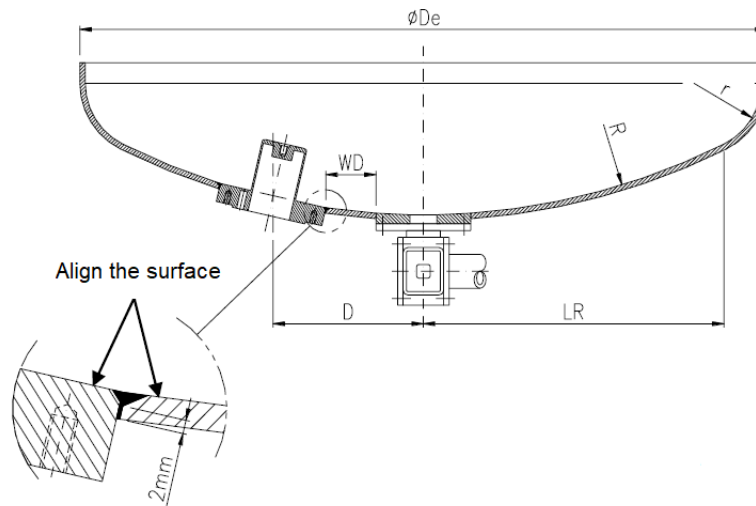

Fig. 3

5.5.3 Welding instructions

The intent of the following instructions is to avoid deformation of the shroud due to weld phase.

5.5.3.1 Before welding

Make sure that the shroud pivot is removed. Using a welding method that is not in contrast with the vessel technical specifications.

5.5.3.2 Positioning and welding of the shroud (outside vessel)

After having cleaned the working surfaces:

- place the shroud into the vessel hole checking that the inner surface of the vessel is flush with the outer edges of the shroud as shown in figure 3.
- check the alignment of the shroud holes as described in chapter 5.5.1 and as shown in figure 4.
- tack weld externally of the vessel at A and B, check the alignment and inclination, make necessary corrections (figure 4).

Tack weld at C and D.

5.5.3.3 Welding of the shroud (inside vessel)

After have cleaned the working surfaces tack weld the shroud following the numbers as indicated in figure 5 avoiding to overheat it in excess.

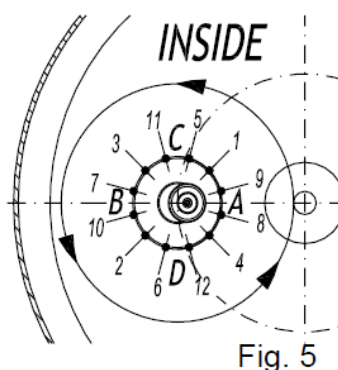

Fig. 5

5.5.3.4 Final welding (inside vessel)

Using filler material, weld the shroud following the instructions as indicated below and see also fig. 6. The procedure is continued until the weld groove is filled according to the vessel technical specifications.

- ◆ First phase:
 - Weld the section “a-b” blow cool with compressed air
 - Weld the section “d-e” blow cool with compressed air
 - Weld the section “g-h” blow cool with compressed air
 - Quench with water and dry well
- ◆ Second phase:
 - Weld the section “b-c” blow cool with compressed air
 - Weld the section “e-f” blow cool with compressed air
 - Weld the section “h-i” blow cool with compressed air
 - Quench with water and dry well
- ◆ Third phase:
 - Weld the section “c-d” blow cool with compressed air
 - Weld the section “f-g” blow cool with compressed air
 - Weld the section “i-a” blow cool with compressed air
 - Quench with water and dry well

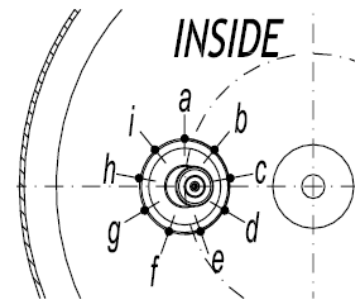

Fig. 6

Attention: do not overheat the shroud, there is a risk of deformation.

5.5.3.5 Final welding

Use the same procedure of the inner vessel above mentioned.

5.5.4 Grinding / polishing

After cooling, the welds can be round and polished according to the vessel technical specifications.

All the mentioned operations must respect the following conditions:

- The welder must be authorized and qualified for these kind of welding operations.
- It is important that the applied heat is well balanced and evenly spread along the weld seam, in order to obtain a weld without imperfections

5.6 BUSHING MOUNTING INSTRUCTION

1. Clean the O-ring (pos. 6) and pivot (pos. 4) seat on the shroud before the installation.
2. Clean the floor for the bushing (pos. 5) on the shroud before the installation.
3. Put the O-ring (pos. 6) in its own seat.
4. Place the bushing (pos. 5) on the shroud checking that the hole (F) coincide with the steady pin (S).
5. Block the bushing (pos. 5) screwing the pivot (pos. 4), having already placed the O-ring (pos. 7) on the pivot.
6. Tighten the pivot (pos. 4) with maximum torque 22 Nm.
7. Place the impeller (pos. 2) on the bushing.

ATTENTION: Before the start up, check that the sense of rotation of the mixer is the same as shown in the scheme by the arrow.

ATTENTION: Do not damage the inside rotor, the impeller and the shroud, while removing from original seat.

ATTENTION: The installation of impeller (pos. 2) must be done in place.

DO NOT TRANSPORT the tank with the impeller installed.

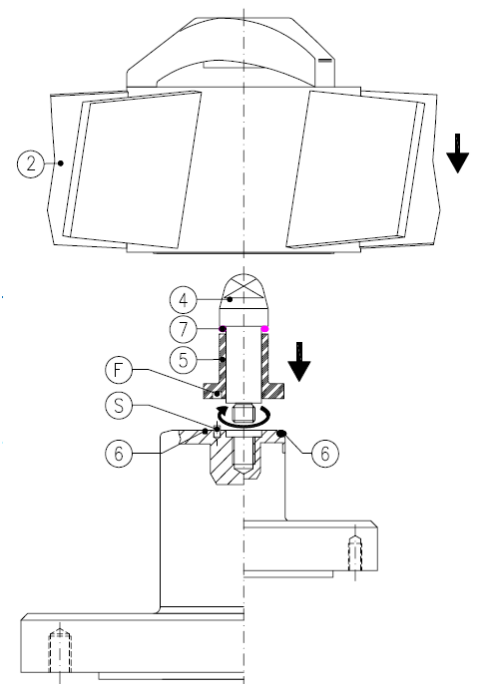

5.7 PIVOT MOUNTING INSTRUCTIONS

5.7.1 For BMA-100, BMA-125 and BMA-150

1. Clean the floor for the pivot (pos. 4) on the shroud before the installation.
2. Leave the O-ring (pos. 7) in its own seat if present.
3. Before placing the pivot on the shroud, remove the steady pin (S) if present.
4. Screw the pivot (pos. 4), with the O-ring (pos. 7), already placed on the shroud.
5. Tighten the pivot (pos. 4) with maximum torque 22 Nm.
6. Place the impeller (pos. 2) on the pivot (pos. 4).

ATTENTION: Before the start up, check that the sense of rotation of the mixer is the same as shown in the scheme by the arrow.

ATTENTION: Do not damage the inside rotor, the impeller and the shroud, while removing from original seat.

ATTENTION: The installation of impeller (pos. 2) must be done in place.

DO NOT TRANSPORT the tank with the impeller installed.

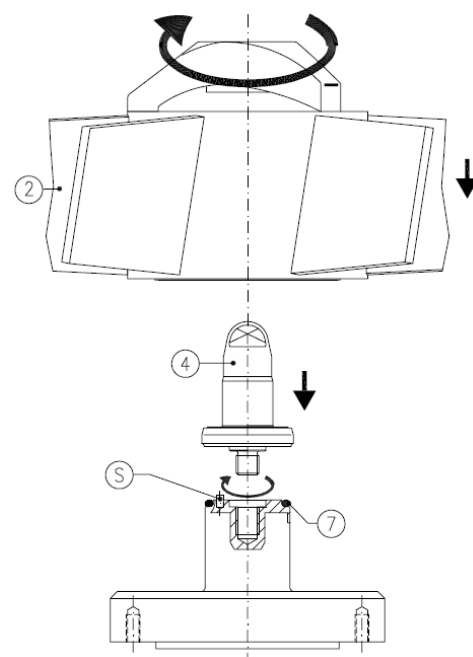

5.7.2 For other models

1. Clean the O-ring (pos. 6) seat on the pivot (pos. 4).
2. Clean the floor for the pivot (pos. 4) on the shroud before the installation.
3. Leave the O-ring (pos. 7) in its own seat if present.
4. Before placing the pivot on the shroud, remove the steady pin (S) if present.
5. Screw the pivot (pos. 4) with the O-ring (pos. 6).
6. Screw the pivot (pos. 4) with maximum torque 22 Nm.
7. Place the impeller (pos. 2) on the pivot (pos. 4).

ATTENTION: Before the start up, check that the sense of rotation of the mixer is the same as shown in the scheme by the arrow.

ATTENTION: Do not damage the inside rotor, the impeller and the shroud, while removing from original seat.

ATTENTION: The installation of impeller (pos. 2) must be done in place.

DO NOT TRANSPORT the tank with the impeller installed.

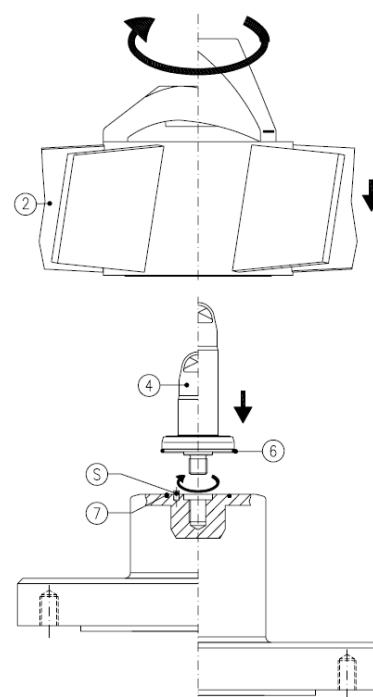

5.8 POSITIONING ON THE TANK



When positioning the machine at the installation site, check that:

- The maneuvering spaces around the machine during its operation are sufficient and suitable for both the control unit (outside the tank) and for the shaft and impeller (inside the tank).
- Check the suitability of the machine housing structure. The sizing and finishes must be fully capable of withstanding the weight of the machine and the stresses transmitted from the machine to the structure, and must guarantee the standards required by the intended fastening type (threaded bars, screws, etc.). The supporting structure must not show any weaknesses that could transmit vibrations or oscillations to the machine, compromising its stability and operating safety.
- When coupling the AGITATOR with the tank, avoid collisions with the shaft while inserting it into the tank. Impacts can affect the shaft alignment, the bearing position and the integrity of the mechanical seal (if any).

5.9 GROUNDING



The equipment must be grounded to reduce the risk of static sparks and electric shocks. Electric or static sparks can cause ignition or explosion in explosive atmospheres.

Check local electrical codes for detailed instructions on grounding procedures applicable to the place of use and the type of equipment.

To ground pneumatic / hydraulic AGITATORS, connect one end of the ground cable to the ground connector on the AGITATOR as shown, otherwise connect the cable to the terminal board of the electric motor. Connect the other end of the ground cable to an effective grounding point.

5.10 CONNECTING THE POWER SUPPLY



For versions equipped with an electric motor, only specialist personnel may connect the machine to the system electrical panel, and only in accordance with good practice and the safety standards in force.

Always connect the machine to an efficient and controlled grounding network.

If in doubt about the efficiency of the network, do not connect the machine.

The user is required to provide an adequate power line disconnecter upstream from the system, as well as an effective means of protection against overcurrents and indirect contact.

When connecting, check:



- that the mains voltage corresponds to the voltage and frequency specified on the plate;
- that the main power line is equipped with an adequate grounding system;
- that you have correctly applied the instructions for installation and use of the electrical components supplied with the machine;
- that you have carried out all the preparations and electrical connections in accordance with the technical reference standard EN IEC 60204-1: 2018;

When making the electrical connection to the machine:

- isolate the machine and upstream components from any possible energy source;
- consult the manual of the electric motor supplied;
- remove the cover from the motor terminal box;
- follow the instructions for connecting to the terminal board shown on the back of its box;
- connect the motor ground terminal to the protective conductor.

The installer must equip the motor power supply with a circuit breaker or a magnetic starter with overload and undervoltage protection, a thermal relay and fuses installed upstream.

The electrical protection for the motor (fuse and thermal, or contactor), must correspond to the rated consumption of the motor.

	CAUTION! Equip the machine with a padlockable power supply disconnecter device, with shape, size and physical construction such as to guarantee correct use by the operator. Install it near the machine, away from danger zones and at a height from the ground that allows access without effort or disturbance. Use a label to identify its function locally.
	CAUTION! Before making any type of electrical connection, the specialist personnel qualified to carry out work on electrical parts and components must have read and understood the contents of the instruction manual of the electric motor in the machine attached to this manual.
	CAUTION! If the motor uses PTC temperature sensors, the user must connect the sensors according to the instructions in the use and maintenance manual of the motor, so that the power supply to the AGITATOR is cut off in the event of thermal overload.

5.11 MOTOR – ELECTRICAL CONNECTIONS



The motors supplied may be pneumatic, hydraulic or electric.



To make the electrical connections (single-phase and three-phase motor) carefully follow the indications on the motor plate and terminal board.

Install a suitable motor circuit breaker between the power supply line and the motor and set it to the rated current in amperes specified on the plate.

The cable entry into the terminal board must be well insulated, and the cover must be screwed on carefully.

Connect the motor ground terminal to the existing ground system.

The AGITATOR must turn in the direction indicated by the arrow.

	CAUTION! Carefully read all parts of the motor manual, attached to this manual, as the information given in this paragraph does not cover all the issues related safe motor use.
	CAUTION! To protect motors powered by inverters, connect the PTCs as described in the motor use and maintenance manual.

TERMINAL BOARD CONNECTION DIAGRAM

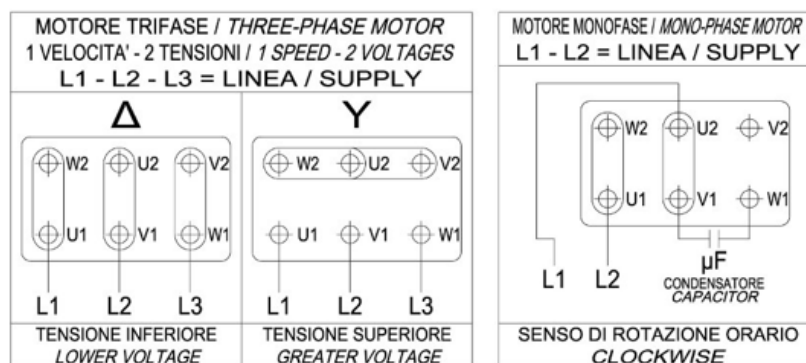

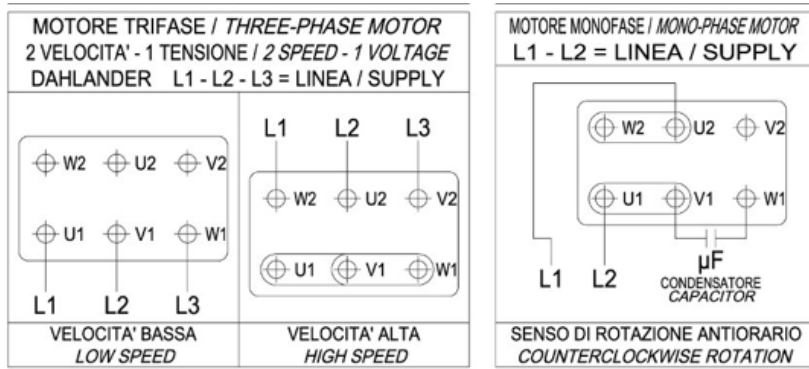

Terminal board connection diagram

6. Using the machine



6.1 INTENDED USE

AGITATORS are used for mixing liquids and liquids containing powders.

The AGITATOR must only be used in accordance with the technical data and specifications given in this instruction manual and in the instruction manuals of its individual components (motor, gearbox, seal, etc.).

All other uses as well as any modifications are prohibited.

6.2 IMPROPER AND PROHIBITED USES

Do not:

- use the machine for operations other than those described in the "intended use" paragraph;
- use the machine in a build configuration other than that intended by the manufacturer and represented in the relative demonstration;
- use the machine if the guards have been tampered with and / or removed;
- connect the machine to energy sources other than those intended by the manufacturer;
- use the machine to mix / stir liquids with environmental conditions and density and viscosity values other than those set out in the specifications;
- use the machine when unscheduled maintenance is required;
- use the machine without liquids in the tank.

6.3 START-UP

Perform the following checks before starting the AGITATOR.

	<p>CAUTION!!</p> <p>Before start-up, check:</p> <ul style="list-style-type: none"> – ATEX compliance of any accessory or device connected to the AGITATOR – That the atmosphere in the place where the AGITATOR must operate is compatible with the ATEX marking specifications – That the maximum temperature of the AGITATOR surfaces does not exceed the value specified on the plate. – The user must install a probe in the appropriate well to monitor and limit the temperature, as indicated in the assembly drawing attached to the AGITATOR manual. Comply with the installation and use instructions of the probe. – The user must install a monitoring system with a temperature limit of 100 °C. <p>Clean the AGITATOR after installation, and make sure that there is no dust build-up thicker than 5 mm.</p> <p>Strictly observe the periodic cleaning procedures to avoid the formation of hazardous layers of dust.</p>
--	--

	<p>CAUTION!</p> <p>Carry out a general check before starting the AGITATOR to make sure you have complied with all the rules set out in paragraph "5.4 Installation".</p> <p>Specifically:</p> <ul style="list-style-type: none"> – check that the AGITATOR is mounted in the intended position – check that the gearbox oil level, if any, is as expected and that there are no lubricant leaks from the caps or seals – check that the power supply voltage of the electric motor matches the rated one <p>Immediately stop use in the event of abnormal operation; contact our technical department.</p>
--	--

6.3.1 Gearbox check

Carefully check the oil level before starting the AGITATOR.

The gearboxes can have three types of lubrication:

- Gearboxes supplied without oil:

In this case, fill with the supplied oil up to the maximum level on the sight glass.

They are equipped with a warning plate and a breather plug for filling the gearbox.

- Gearboxes supplied with oil:

These are supplied with solid plugs and are equipped with a warning plate and a breather plug.

In both cases, during installation, the breather plug must be inserted in place of the plug located at the highest position to avoid overpressure in the casing during operation.

Check the oil level with the frequency specified by the manufacturer (manual attached).

- Gearboxes supplied with oil or grease "for life":

The gearboxes supplied with permanent lubricant with grease or oil "for life" do not have a filler, level and drain plugs, and do not require maintenance.

	<p>CAUTION! Carefully read all parts of the gearbox manual, attached to this manual, as the information given in this paragraph does not cover all the issues related safe gearbox use.</p>
---	--

6.3.2 Variator check

Check the oil level before starting the AGITATOR.

Variators supplied without oil: In this case, fill with the supplied oil up to the maximum level on the sight glass.

Some types of variators are supplied with non-perforated plugs and are provided with a breather plug that, during installation, must be inserted in place of the plug located at the highest position, to avoid overpressure caused by splashing and heating of the oil during operation.

Movement can be varied by adjusting the variator control handwheel.

N.B. Never operate the variator control handwheel with the speed variator stopped.

	<p>CAUTION! Carefully read all parts of the variator manual, attached to this manual, as the information given in this paragraph does not cover all the issues related safe variator use.</p>
---	--

6.3.3 Seal check

- Lip seal rings / Oil seal rings:

This sealing system involves the use of two types of seals, depending on the operating pressure:

- lip seals are used for low pressures.
- lip seals or oil seals are used for atmospheric pressure

No preliminary operation is required as the seal is ready for service after installation on the AGITATOR control unit.

- Single mechanical seal:

No preliminary operation is required as the seal is ready for service after installation on the AGITATOR control unit.

Check if the seal model is suitable for one or both directions of rotation.

In the case of side AGITATORS, where the seal is below the liquid level, make sure that it is always in contact with the liquid; ensure that there is no air build-up (air bubbles) in areas around the seal when emptying and subsequently filling the tank.

- Double mechanical seal:

This must be used with a coolant; this liquid must circulate in the seal housings, even before starting the AGITATOR.

Generally, the liquid circulating between the seals must be kept at a pressure 1 atm. higher than that in the container (unless otherwise specified by the mechanical seal supplier).

	CAUTION! Remove the seal locking supports (if any) before starting the AGITATOR.
---	--

	CAUTION! Carefully read all parts of the seal manual, attached to this manual, as the information given in this paragraph does not cover all the issues related safe seal use.
---	--

6.3.4 Pressurization cylinder check (if any)

It is important that the mechanical seal coolant is clean and not excessively viscous, has good thermal conductivity and a high boiling point, and is compatible with the fluid in the tank.

Check that all the connection pipes are connected and, where applicable, connect the pipes for the cylinder cooling. If the coolant recirculation pump is sealed, check the electrical connection.

Check the correct flow rate of the flushing system.

	CAUTION! Equipment lubricating and / or refrigerating fluids must have an ignition temperature (IEC 60079-20-1) of at least 50 K above the maximum surface temperature of the equipment in which they are contained.
---	--

6.3.5 Impeller check

The impellers are the parts that rotate in the liquid to transform the energy transmitted by the drive unit in order to achieve the set objectives.

They can be of different shapes and sizes, but they can be divided into two main categories:

- AXIAL – These consist of "vertical AGITATORS" that push the product towards the bottom, from which it then rises up the walls. They provide high flow rates and different amounts of shear or head, depending on the shape and total surface.
- RADIAL - These provide high shear and a low flow rate, and push the liquid onto the side walls of the vessel, causing it to go both up and down.

Check that the impellers are positioned and tightened correctly on the shaft.

	CAUTION! Do not start the AGITATOR if the impeller is immersed in sedimented material, unless this mode of operation was considered in the design.
---	--

6.3.6 Magnetic drive system:

The drive system requires no maintenance.

Once the above checks have been carried out, the AGITATOR can be started with the control devices provided.

When a reduction gear - speed variator is installed, the following is generally recommended:

- gradually increase the transmitted power over time, starting from the minimum values;
- or limit it (50–70% of maximum power) for the first few hours of operation.

In the even of unexpected excessive absorption, disconnect the motor from the mains power, make sure that the connections are making perfect contact, and check that the operating conditions are correct, especially regarding the liquid density and viscosity; if the overload persists, contact our technical office.

If there are vibrations, immediately stop the AGITATOR and search for the causes that may have produced them.

A strong vibration in variable speed AGITATORS driven by an inverter or mechanical variator can indicate that the shaft is operating close to a critical flexural speed.

In this case, stop the AGITATOR immediately and contact our technical office to check the critical speed calculations.

All AGITATORS are suitable for operation with a constant maximum level.

Avoid operation in tanks with variable or insufficient level, unless specifically designed for these conditions.

6.3.7 Entire unit check

- Check the tightness of all the bolts (repeat this step after two weeks of operation).
- Check that the AGITATOR is rotating in the direction of the arrow.
- Check the protection and control systems adopted.
- Check the all equipment is grounded.

- Check that the shaft turns by turning the motor fan manually.
- Check that there nothing is hindering movement.
- Check the distance between the impellers and the bottom and sides of the tank.
- Make sure that there is no abnormal noise or vibration.

Once the above checks have been carried out, the AGITATOR can be started with the control devices provided.

When a reduction gear - speed variator is installed, the following is generally recommended:

- gradually increase the transmitted power over time, starting from the minimum values;
- or limit it (50–70% of maximum power) for the first few hours of operation.

In the even of unexpected excessive absorption, disconnect the motor from the mains power, make sure that the connections are making perfect contact, and check that the operating conditions are correct, especially regarding the liquid density and viscosity; if the overload persists, contact our technical office.

If there are vibrations, immediately stop the AGITATOR and search for the causes that may have produced them.

A strong vibration in variable speed AGITATORS driven by an inverter or mechanical variator can indicate that the shaft is operating close to a critical flexural speed.

In this case, stop the AGITATOR immediately and contact our technical office to check the critical speed calculations.

All AGITATORS are suitable for operation with a constant maximum level.

Avoid operation in tanks with variable or insufficient level, unless specifically designed for these conditions.

7. Safety



7.1 DANGER ZONES AND RESIDUAL RISKS

The danger zones on the machine are mainly near the motor, while the residual risks depend on the stage of the machine life cycle: "Handling and transport", "Installation", "Operation" and "Maintenance".

Life cycle stage	Zone	Type of risk	Symbol
Transport and handling	Entire unit	Impact with parts of the machinery being moved Fall of material from above while fitting on the tank	
Installation	Electric box / electric motor	Electrocution due to direct contact during electrical wiring	
Operation	Electric motor	Burn resulting from contact with the motor casing during prolonged periods of use under maximum permitted load.	
		Electrocution due to indirect contact	
Maintenance	Electric motor	Electrocution due to direct contact during electrical maintenance. <i>Only qualified personnel may carry out maintenance work that requires the presence of electricity, and only in accordance with the safety procedures inside the system in which the machine is installed.</i>	
	Mechanical parts	Cuts and / or abrasions due to contact with metal parts	

Warning signs for the operator have been applied to the machine.

	<p>ELECTRIC SHOCK HAZARD</p> <p>Only qualified personnel may carry out maintenance work that requires the presence of electricity, and only in accordance with the safety procedures inside the system in which the machine is installed.</p>
--	--

7.2 SAFETY DEVICES AND GUARDS INSTALLED

The mechanical safety devices in the machine consist of the casings and "machine" bodies of the motor and gearmotor components.

8. Maintenance



8.1 SAFETY PRECAUTIONS

Those in charge of and the operators involved in machine maintenance, must be aware of the need for strict compliance with all the requirements set out by the safety authorities, in addition to the specific operations listed in this chapter.

All information on maintenance is related exclusively to routine maintenance, which is intended to ensure correct daily machine operation.

Check that the tools available are suitable for use, never use tools or equipment improperly.

If additional instructions are required or if particular problems arise, do not hesitate to contact the person in charge. To avoid malfunctions, which in turn could directly or indirectly lead to serious accidents or harm to people or property, it is very important to observe all the instructions on the machine, in the diagrams, in the attached documentation and in this document.

	<p>CHECK THAT SAFETY DEVICES AND GUARDS ARE IN GOOD WORKING CONDITION</p> <p>All or some guards and safety devices can be removed during maintenance work by specialist and / or authorized personnel, who will reinstall them in their original positions as soon as the maintenance work has been completed. Guards can only be removed for maintenance with the authorization and supervision of the "person in charge" of maintenance. After the maintenance work, the "person in charge" of maintenance must make sure that the guards are installed correctly and are working. The machine cannot be started up after maintenance work until the guards and other devices have been reinstalled.</p>
---	---

	<p>CAUTION!</p> <p>Equipment maintenance must be carried out without an explosive atmosphere.</p> <p>Clean any dust deposits from the outside of the AGITATOR to ensure that they do not exceed 5 mm.</p>
---	--

When carrying out maintenance work, disconnect the power supply for the duration of the work and take all precautions to ensure that the equipment cannot operate during the work.

The equipment must be cleaned as recommended by the installer, according to the installation environment; do not clean with solvents and / or abrasive materials as they can compromise the safety of the AGITATOR.

	<p>CAUTION!</p> <p>Never let the AGITATOR run dry, even during testing, verification and start-up; make sure that the pin / bush area is immersed to ensure lubrication.</p>
---	--

The AGITATOR does not require special assistance during operation as long as all the suggestions contained in this manual are respected.

After the first 500 hours of AGITATOR operation, replace the oil in the reduction gear, if any, possibly providing a thorough internal washing. Gearboxes with synthetic grease or "life-long" oil do not require any maintenance. Check the lubricant level in the gearbox at regular intervals and, generally, change it every 4000 working hours unless otherwise indicated.

Sealed, ceramic or hybrid bearings do not need any maintenance.

Change the bearing grease with the AGITATOR stopped.

To ensure longer equipment service life, we recommend carrying out thorough maintenance, replacing the parts most subject to wear.

8.1.1 LOTO maintenance procedure (LOCKOUT-TAGOUT)

	<p>MAINTENANCE SAFETY WARNINGS</p> <p>If the AGITATOR is installed on a tank or other equipment for which a manhole or openings are provided to allow insertion of parts of the body that can reach the rotating parts of the AGITATOR, the user must provide a safety switch on the manhole / opening that, if open, cuts off the AGITATOR and</p>
---	---

prevents it from being activated.

The user must adopt lockout / tagout procedures (LOTO).

To avoid risks posed by unexpected start-up of the AGITATOR while carrying out maintenance on the machine / system in which it is installed, or reactivation caused by:

- a start command resulting from a control system failure;
- an involuntary action on a start command or a signal from a sensor that activates a command;
- restoration of the power supply after it was cut off;

The user must provide Lockout / Tagout procedures (LOTO) to safely isolate power sources and raising the level of safety during routine and extraordinary maintenance by controlling hazardous energy.

Lockout: means placing a padlock on an isolation device (disconnecter, valve, etc.) of any energy source (electrical energy, pneumatic energy, hazardous fluid, etc.) in the OFF position.

Tagout: means placing a sign or label near the padlock used for the lockout, clearly showing the name of the authorized operator.

Below is an indication of the basic steps of the procedure to be adopted. For further details, refer to **EN ISO 14118: 2018** standard "safety of machinery - prevention of unexpected start-up", a necessary tool for training maintenance staff:

Hazard identification

First of all, it is necessary to identify the hazardous energy sources of machines / systems:

- electricity (mains, capacitors, ...)
- compressed air
- fluids under pressure (accumulators, pressure tanks,)
- high temperature fluids
- hazardous chemicals

After identifying the types of energy to be neutralized (mechanical, electrical, pneumatic, etc.), the means of blocking the source must be chosen and provided (valve closure, power cut-off, etc.).

Stop

Stop the operation of the equipment and machinery involved in the normal way.

Notification

It is necessary to inform all the persons concerned that work will be carried out on the machinery by locking it.

Lockout

It is necessary to isolate the energy sources with the identified cut-off devices (e.g. open the main switch on the machine, close the fluid shut-off valves, etc.)

This must involve a physical lock to prevent the system from restarting.

Each person working on the work equipment shall have their own identified lock.

Control and release of stored energy

To be sure that the machinery is completely isolated, a test must be performed on all the controls of the systems and electrical circuits on which the work is to be carried out, and any residual energy must be eliminated (pressure elimination, capacitor and accumulator discharge, etc.).

After checking that there are no exposed person, attempt to start up the equipment with normal control functions, to verify that the machine / system is not working and that all energy sources are isolated.

Tagout

Identify the lockout by indicating the date and name of the personnel who carried it out.

Lockout removal

Only at the end of the maintenance work, after:

- checking the equipment and all parts connected between the equipment under work and the energy isolation device,
- informing all people affected by the locking that the lockout has ended

the padlocks can be removed and the equipment can be powered up again.

Each padlock can only be removed by the operator indicated on the Tag.

Special precautions must be taken for work that extends over several shifts, or if an authorized operator has to be absent.

8.2 ROUTINE MAINTENANCE

8.2.1 AGITATOR components external to the tank

PERIODIC CHECKS

MOTOR: Follow the manufacturer's maintenance instructions	
GEARBOX: Follow the manufacturer's maintenance instructions	
VARIATOR: Follow the manufacturer's maintenance instructions	
FREQ.	TYPE OF MAINTENANCE
1 month	LIP SEAL/OIL SEAL: Check that there are no leaks from inside the tank to the outside
1 month	PRESSURIZATION CYLINDER: Check the liquid level Check that there are no leaks from the various gaskets.
3 months	O-RING: Check the condition of the sealing gaskets if any.
6 months	V-BELTS (antistatic): Check the wear of the V-belts and replace them if they show signs of wear, elongation or even minor damage
6 months	FLEXIBLE COUPLINGS: Check the flexible parts of the coupling and replace them if worn
after the first 100 hours and every 6 months thereafter	AGITATOR: Check the tightness of the bolts that connect the AGITATOR flange to the tank flange. Check the tightness of all the bolts of the components that transmit motion.
1 year	AGITATOR: Check that the outer rotor is not damaged.

8.2.2 AGITATOR components inside the tank

PERIODIC CHECKS

FREQUENCY	TYPE OF MAINTENANCE
6 months	Check the wear of the bushing and send the internal rotor to INOXPA if necessary.
6 months	Check the wear of the pin and its gasket, and replace them if necessary.
1 year	Check the corrosion of the parts in contact with the product.

8.2.3 Tightening torques

The tightening torques of the main connections in the AGITATORS are shown below

TORQUE OF BOLTS TIGHTENING			
THREAD	MATERIAL		
	STAINLESS STEEL CLASS 70	CARB. STEEL CLASS 8.8	CARB. STEEL CLASS 10.9
M6	5.9 Nm	9 Nm	13.2 Nm
M8	14.5 Nm	21.6 Nm	31.8 Nm
M10	30 Nm	43 Nm	63 Nm
M12	50 Nm	73 Nm	108 Nm
M16	121 Nm	180 Nm	264 Nm
M20	224 Nm	363 Nm	517 Nm
M24	400 Nm	625 Nm	890 Nm
M30	640 Nm	1246 Nm	1775 Nm
M36	1100 Nm	2164 Nm	3082 Nm

8.3 CLEANING

The equipment must be cleaned as assessed by the user, according to the installation environment; do not clean with solvents and / or abrasive materials as they can compromise the safety of the AGITATOR.

To keep the work area safe:

1. Keep the work area clear of any type of material that could hinder the work of operators.
2. Keep the surrounding areas clean; in particular from oils, greases etc. which can make the floor slippery.
3. Use suitable vacuum cleaners and equipment.

8.4 EXTRAORDINARY MAINTENANCE

Extraordinary maintenance work refers to replacement of worn components

To carry out such work, always contact the manufacturer to order the spare parts listed in the next paragraph.

For details on extraordinary maintenance work, refer to the attached procedure.

8.4.1 Spare parts

- Guide pin
- Guide bushings
- O-ring

To order spare parts, refer to the attached assembly drawing.

8.4.2 Troubleshooting

	FAULT		POSSIBLE CAUSE	SOLUTION
1	The AGITATOR does not start up	a	Power supply is missing or insufficient	Check for the electrical power supply and that the available power complies with the data on the motor identification plate
		b	Inadequate fuses (low rated current)	Replace the fuses with suitable ones (see Electric Motor Manual)
		c	Blown fuses due to damaged motor or cables	Repair the motor and / or replace the cables (see instructions in the Motor manual)
		d	Overload protection has tripped	Reset the protection (see Fault 2 if it trips again)
2	The overload protection trips	a	It is set to the wrong value	Adjust the setting or replace the protection
		b	One phase is missing	Check the power supply and fuses
		c	Encrustations on rotating or impeller parts immersed in solid sediments	Remove encrustations and sediments from the impellers
		d	The density or viscosity of the stirred product is higher than expected	Contact the manufacturer for assistance
		e	Defective bearings	Grease or change the bearings
3	Abnormal sound emission and vibration	a	The impellers spin in the air or produce cavitation due to a low liquid level	Increase the liquid level and keep it as constant as possible
		b	Unbalanced impellers (bent, worn or encrusted blades)	Increase the liquid level and keep it as constant as possible, or replace the impeller(s)
		c	Shaft not straight	Check the shaft straightness or replace it
		d	Defective bearings	Grease or replace the bearings
		e	Defective motor fan	Replace the motor fan
		f	Defective speed variator or reduction gear	Check the oil level and repair or replace the defective part
		g	Inadequate gearbox lubricant	Replace the lubricant according to the instructions in the gearbox manual
4	Insufficient or no mixing	a	Wrong direction of rotation	Reverse the direction of motor rotation (according to the instructions in the Motor Manual and in accordance with the direction of rotation indicated on the control unit)
		b	The characteristics of the liquid or the dimensions of the tank are different from those specified in the sales documents	Contact the manufacturer for assistance
5	Motor, support or bearing housing temperature is too high	a	The motor is overloaded and the overload protection is defective or set incorrectly	(See Fault 2); check the overload protection
		b	Defective motor fan or its grille is too dirty or there is insufficient space for the cooling air to pass	Check the motor fan, clean its grille and make sure that the cooling air can circulate freely
		c	Mechanical variator or reduction gear lubricated poorly, too much or with inappropriate lubricant	Refill, reduce or replace the lubricant
		d	Temperature of the product to be stirred and / or of the operating environment	Check and reduce the product and / or ambient temperatures, or contact the manufacturer

9. Disassembly and disposal



9.1 DISASSEMBLY SEQUENCE

Caution:

Before disassembling the device, make sure that there are no hazardous process conditions, e.g. pressure in the tank, high temperatures, aggressive or toxic products, etc.

Follow the instructions given in chapter “5. INSTALLATION” and proceed in the same way, but in the reverse order.

	<p>CAUTION!! The cover of the enclosure on Ex devices may only be opened in a safe area or in the proven absence of an explosive atmosphere.</p>
--	---

	<p>CAUTION! do not damage the rotors, the pin and the shroud when moving them away from their seats</p>
--	--

9.2 DISPOSAL

	<p>CAUTION! Consult the demolition legislation in force in the user's country to find out about any "inspection body" to be contacted or "reporting" procedures to be adopted.</p>
	<p>CAUTION! When the machine is to be put out of operation for prolonged times pending dismantling, it is advisable to delimit the area and post “no access to unauthorized persons” signs.</p>

The machine is built with materials that do not pose particular hazards to the operator during demolition.

The operator or persons responsible for disposal must consider that the materials of which the machine is made are not of a hazardous nature and essentially consist of:

- steel;
- electric motor;
- polypropylene and various plastics;
- electric cables with relative sheaths;
- rubber gaskets.

When demolishing and disposing of the machine, the operator must take all necessary precautions to avoid creating risks associated with dismantling the equipment, similar to those prescribed for installation.

In particular, special precautions must be taken during the following stages:

- Disassembly of the machine from the operating area.
- Transport and handling.
- Separation of materials.

The operator will have to manage the waste (i.e. substances or objects that the holder discards or has decided or is obliged to discard) as required by Community Directive 2008/98 / EC (as amended) on waste, Regulation (EU) no. 1357/2014 on hazardous waste, and Directive 94/62 / EC (as amended) with Regulation (EC) 219/2009 on packaging and packaging waste (for Italy see Legislative Decree 152 of 13/04/2006 "Environmental standards") so that waste can be recovered or disposed of without endangering human health and without using processes or methods that could harm the environment, in particular:

- without creating risks to water, air, soil, fauna and flora;
- without causing inconvenience from noise or odors;
- without damaging the landscape and sites of particular interest, protected under current legislation.

CAUTION: all plastic parts must be recovered and disposed of in accordance with the legal provisions defined for the type of material, in accordance with the applicable laws in force on safeguarding and protecting the environment.



Disposal of waste electrical and electronic equipment (WEEE) subject to the RoHS directive. Electrical and electronic equipment (WEEE) bearing this symbol must be subject to separate collection.

NOTE

For any questions or queries regarding machine demolition / disposal procedure or topics not covered in this technical document, contact the disposal staff.

How to contact INOXPA S.A.U.:

Contact details for all countries are continually updated on our website.

Please visit www.inoxpa.com to access the information.



INOXPA S.A.U.

Telers, 60 – 17820 – Banyoles – Spain

Tel.: +34 972 575 200 – Fax.: +34 972 575 502